

**MAKING
FITNESS
MORE
COLORFUL**



LifeFitness

IC7 INDOOR CYCLE

The ultimate power-based Indoor Cycle and program redefines how instructors perform and how exercisers experience indoor cycling in the studio and on the cardio floor. The final achievement was something much greater - making fitness more colorful.

LifeFitness

INTRO

- Making fitness more colorful **4-5**
- The IC7 Indoor Cycle **6-7**
- The science behind Coach By Color® **8-9**

FEATURES

- WattRate® Direct Power Meter **10-11**
- Self-powered generator **12-13**
- Two-stage drivetrain **14-15**
- User-assist posts and adjustments **16-17**

COMPUTER 2.0

- Intro **18-19**
- New features **20-21**
- Connectivity & training zones **22-23**

SPECS

- IC7 Indoor Cycle specifications **24-25**

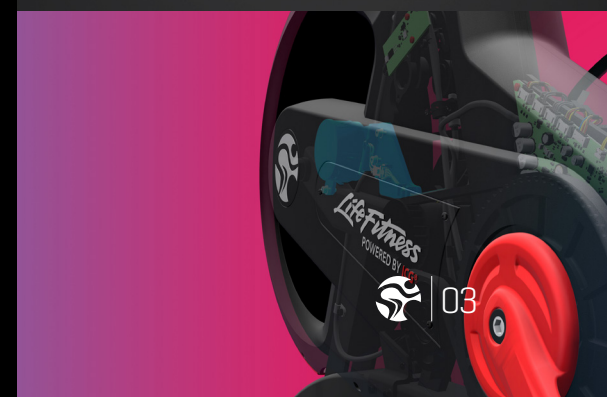

MAKING FITNESS MORE COLORFUL

The award-winning IC7 Indoor Cycle brings optimal performance to group exercise, team coaching, personal training and individual use. World-class technology and member-centric coaching make your program more colorful, meaning better experiences and better results for your exercisers.

WATTRATE TFT COMPUTER 2.0

The IC7's WattRate® TFT Computer 2.0 uses one of the world's most simple and powerful forms of communication to maximize instruction, motivation and reward during workouts. The display lights up in one of five colored zones to match the user's WattRate® power reading or heart rate output so they know immediately whether they need to ratchet up or dial back their effort.

WATTRATE DIRECT POWER METER

The WattRate® Direct Power Meter provides exercisers with immediate and precise feedback on the effort they're putting in to ensure they have absolute control of the results they achieve. Power-based training with WattRate® - the market's most accurate power meter - provides a faster way for exercisers to see results and reach goals.

PREMIUM PRODUCT DESIGN

Black anodized components, superior biomechanics and precision engineering provide riders with maximum comfort and performance. When users connect to their workouts and have positive psychological and physiological experiences, it promotes faster results and creates members who look forward to training more at your facility.





**RED FLYWHEEL
ACCENT**

**BLACK ANODIZED
POSTS & SLIDERS**

**WATTRATE® TFT
COMPUTER 2.0**

BLACK ANODIZED FLYWHEEL

LifeFitness

AWARD WINNING DESIGN

IC7 INDOOR CYCLE

The award-winning IC7 is the most advanced indoor cycle ever designed. Its pioneering design and functionality are due largely to an innovative two-stage drivetrain. Freed of the large center pulley characteristic of traditional bike design, the IC7 brings a lower, sleeker profile to the studio or cardio floor. Improvements, aren't limited to aesthetics. The two-stage drivetrain enables the market's most accurate [$\pm 1\%$ deviation] WattRate[®] Direct Power Meter, 100-level precision magnetic resistance, 1:11 ratio high-speed flywheel, and an unrivaled connection to the ride thanks to the tactile and responsive hybrid Poly-V and tooth belt technology. The bike's performance metrics are delivered to the rider via the re-engineered WattRate[®] TFT Computer 2.0 – a fully self-powered computer that vividly displays the user's WattRate[®] power or heart rate to them and their coach in five colored zones. The bike improves an athlete's performance while capturing an artistry that communicates with the exerciser.

THE SCIENCE BEHIND COACH BY COLOR

Life is not black and white. We live in color. Color is powerful. It can spur action and compel reaction. Color is evocative. It can influence thoughts and emotions. Color is universal. Red means “hot” and blue means “cool” in just about every culture.

To Coach By Color® is to use one of the world’s most intuitive and effective forms of communication to improve the exerciser experience. The Coach By Color® power program relies on color’s natural stimulating properties to accurately coach a user’s effort during a workout. It elicits the right psychological and physiological responses to encourage greater effort. It fosters connections among members and enhances instructor communication, and therefore increases social interaction while maximizing results. Those are the kinds of benefits that boost new member acquisition and retention.





Life Fitness
POWERED BY ICG®

**PHOTOCELLS DIRECTLY MEASURE
THE TORSION (TWISTING FORCE)
OF THE SPINDLE**



WATTRATE DIRECT POWER METER

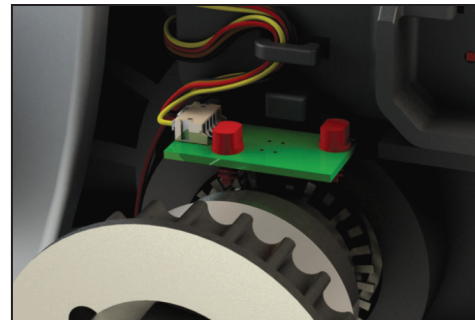

The WattRate® Direct Power Meter is the market's most accurate power meter and offers a direct measuring tolerance of +/- 1%. Such accuracy is groundbreaking in Indoor Cycles. It is located at the intermediate transmission and uses photocells to directly measure the torsion (twisting force) of the spindle.

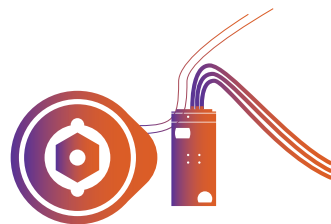

**THE DESIGN NEVER
REQUIRES RECALIBRATION
AND IS FULLY RESISTANT TO
EXTERNAL FACTORS SUCH AS
TEMPERATURE, HUMIDITY
AND TRANSPORTATION.**

SELF-POWERED GENERATOR

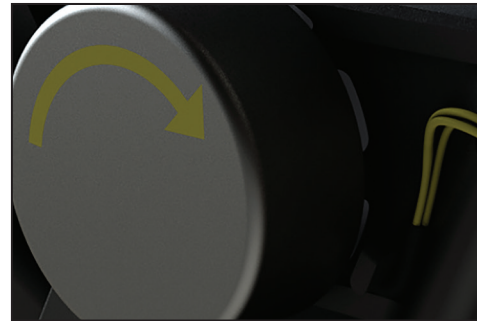
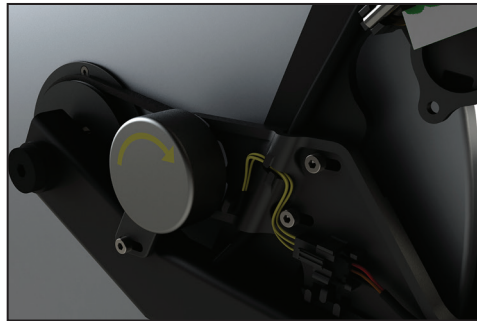

No batteries required. The compact generator at the flywheel captures the rider's energy and recharges the bike's integrated lithium polymer battery. This makes the bike independent from power grids and costly battery replacements.

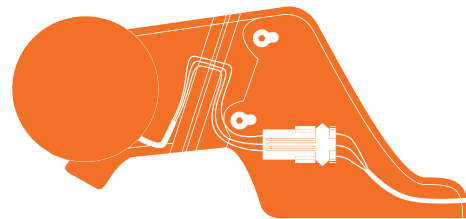

**A COMPACT GENERATOR AT
THE FLYWHEEL
RECHARGES THE BIKE'S
INTEGRATED LITHIUM
POLYMER BATTERY.**

SELF-
POWERING
TECHNOLOGY
FEEDS ALL OF
THE BIKE'S
ELECTRONICS





IC7



Life Fitness
POWERED BY ICG®

ULTIMATE CONNECTION
TO EVERY PEDAL STROKE

Life Fitness

TWO-STAGE DRIVETRAIN

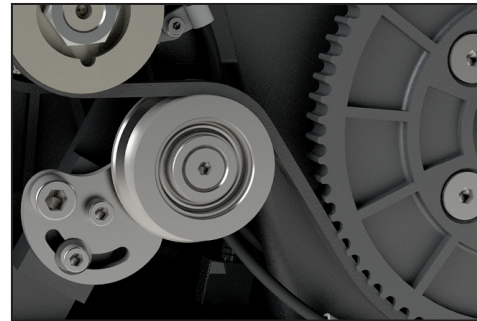
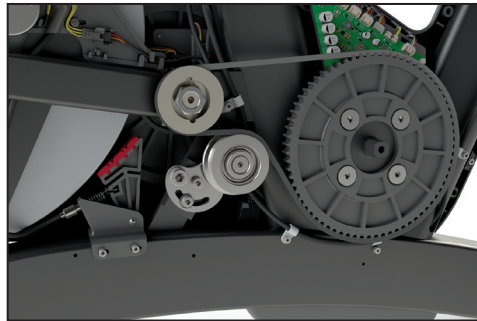

With an immense 1:11 gear ratio, this revolutionary design equipped with ICG's hybrid Poly-V and tooth belt technology is capable of transferring extreme levels of torque smoothly and generates an incredibly fast flywheel speed. Combined, these features create the ultimate connection to every pedal stroke.

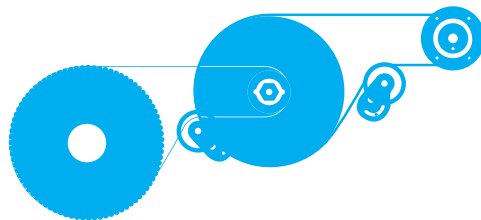

**TWO-STAGE DRIVETRAIN
USES ONE LEFT AND ONE
RIGHT-SIDED PULLEY
SYSTEM TO DRIVE THE
FLYWHEEL.**

MAKING FITNESS MORE COLORFUL

LifeFitness



ERGO-FORMED HANDLEBAR

A wide, soft PVC bar provides larger users with more support. It features time trial bar ends, central ride easy position and it intelligently integrates the WattRate® TFT Computer 2.0 by not exposing any cables and allowing the computer position to adjust in-line with the bars.

ADVANCED BIKE FIT

The offset frame design and stepless four-way (saddle height, saddle fore/aft, handlebar height, handlebar fore/aft) slider and post technology offer superior biomechanics, accommodate the widest range of users, and allow for the finest of fine tuning.

USER-ASSIST POSTS

The gas assisted posts provide users with a smooth, stepless adjustment range. A system that allows the athlete to set up for performance and the everyday exerciser to benefit from maximum comfort.

155MM Q-FACTOR

Q-Factor is the distance between a user's feet when sitting on the bike and pedals. A Q-Factor of 155mm makes the indoor cycle feel more like a real bike. The benefits include increased comfort and efficiency in every pedal stroke.

300-DEGREE MAGNETIC RESISTANCE



WATTRATE® TFT COMPUTER 2.0 WITH MECHANICAL BACK-LIT BUTTONS



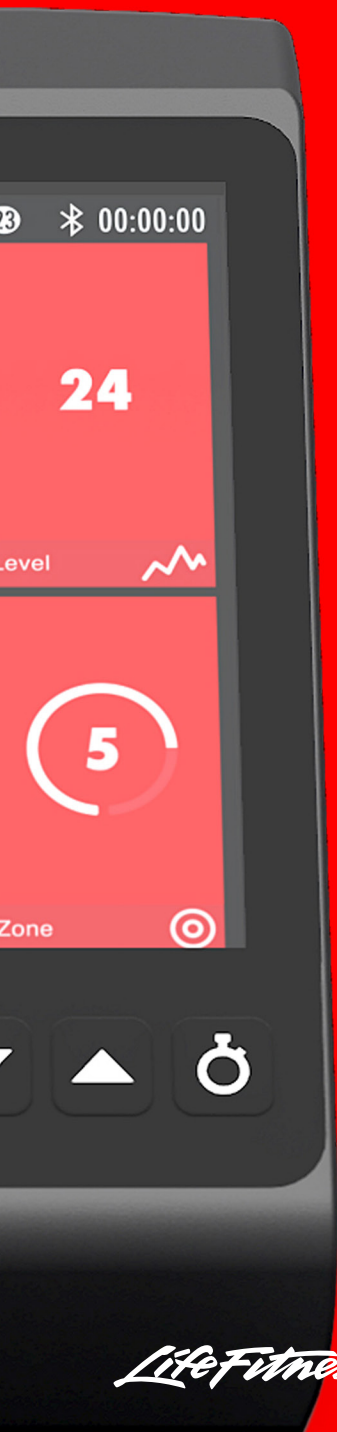

WATTRATE TFT COMPUTER 2.0

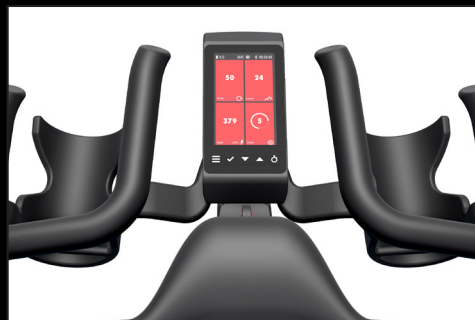

The WattRate® TFT Computer 2.0 was redesigned and reengineered for IC6, IC7 and IC8 Indoor Cycles. It is a robust computer that features intuitive exerciser navigation and high-speed connection.

The computer has a bright, self-powered, fully integrated TFT screen and a front LED display, which simultaneously displays individual training intensity for the user and the trainer.

IT'S NOW POSSIBLE TO CAPTURE TRAINING-RELATED DATA ON EXTERNAL DEVICES, ICG® CONNECT AND THE ICG® TRAINING APP VIA BLUETOOTH AND ANT+

LifeFitness



**THE FRONT LED
DISPLAY CONNECTS
INSTRUCTORS TO
THEIR STUDENTS**



WATTRATE TFT COMPUTER 2.0

UPGRADED SYSTEM HARDWARE

The new computer features an upgraded hardware with increased RAM for a faster operating system.

FTP ON THE FLY

Cycling sessions will be even more accurate with FTP on demand. If one Coach By Color® zone feels too easy or too hard, the FTP value can be adjusted at any time during the ride.

EFFICIENT SOFTWARE UPDATES

No matter how many bikes a studio has, the hidden micro USB port behind the front LED display allows for quick and easy software updates.

REINFORCED COMPUTER HOUSING

Structurally improved, the robust computer housing keeps moisture out for a ride free of interruptions.

LifeFitness



DISPLAY 01

Shows the user's "actual" performance data, including RPMs, resistance level, watts, training zone and dynamic lap function.



DISPLAY 02

Shows further detailed "actual" performance data such as as heart rate, watt / KG and watt / HR.



DISPLAY 03

Provides the user with a quick review of "maximum" and "average" performance values during the workout along with lap statistics.



DISPLAY 04

Displays real-time feedback of a user's time in each training zone, watt rate or heart rate training modes, along with how many miles and calories have been burned in each training zone.

MECHANICAL BACK-LIT BUTTONS

Tactile touch buttons allow for quick and intuitive input selection. And backlighting means that you can easily see the buttons in pitch black rooms during the toughest rides.



WATTRATE TFT COMPUTER 2.0

GO FURTHER FASTER WITH THE LATEST
BLUETOOTH® BLE TECHNOLOGY

Doubling the speed and enhancing the range, Bluetooth 5.0 sets the standard. After pairing with the ICG Training App or third party apps, training data is transferred from the WattRate® TFT Computer 2.0 more accurately, efficiently and in real time. No additional hardware is needed. There has never been a better time to get connected. Via Bluetooth 5.0 and ANT+ you can pair your training apps to view, save and track workout history.



LifeFitness

RPM

Actual cadence

LEVEL

Resistance [0-100]

DOWNLOAD NOW

APP.TEAMICG.COM



ICG TRAINING

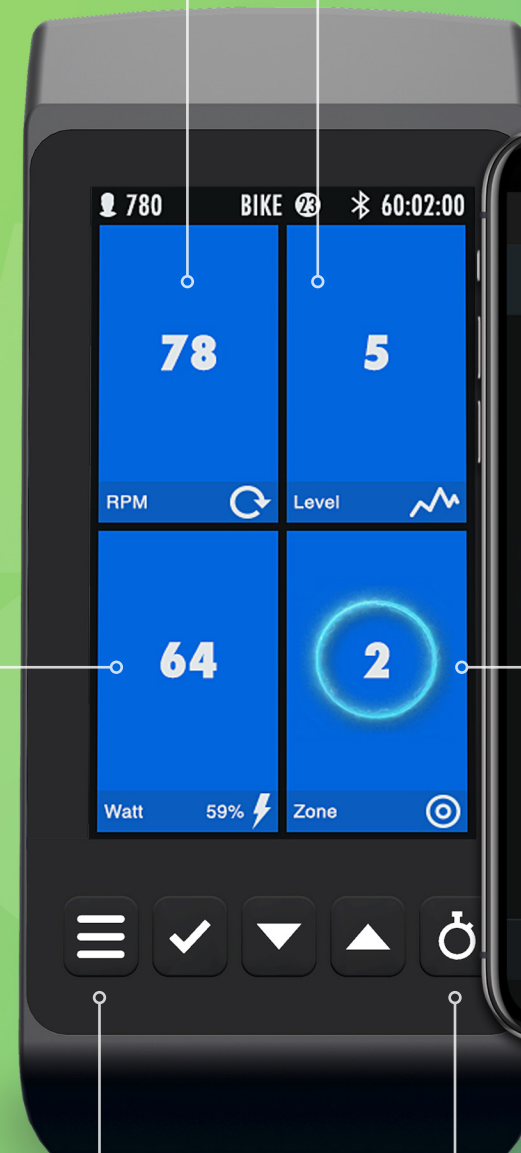

WATTS

Actual power output in watts



ZONE

Current training zone

USER SETTINGS

For personal data entry, and
Coach By Color® options

LAP

To record lap time & distances



WATT RATE TRAINING ZONES

Coach By Color® has five colored training zones: white, blue, green, yellow and red. These zones can be linked to WattRate® power and Functional Threshold Power (FTP), or heart rate and percentage of Heart Rate Max (HRM). FTP represents the workload above which an individual cannot sustain prolonged exercise. Similar to HRM, once an individual's FTP is known, users are assigned the five colored zones to accurately coach their effort for the best customized results.

TRAINING/HEAT* ZONE	%FTP	% MAX HR	RPE	TIME IN ZONE
Burn*	>150%	95 - 100%	Maximal	5 - 10 secs
On Fire*	121 - 150%	92 - 94%	Hard/Maximal	1 - 5 min
Anaerobic Capacity	106 - 120%	91 - 100%	Maximal	1 - 8 min
Lactate Threshold	91 - 105%	81 - 90%	Hard	10 - 60 min
Heat*	85 - 95%	78 - 85%	Moderate/Hard	3 - 8 hrs
Tempo	76 - 90%	71 - 80%	Moderate	3 - 8 hrs
Ignite*	67 - 75%	66 - 70%	Light/Moderate	3 hrs - wks
Endurance	56 - 75%	61 - 70%	Light	3 hrs - wks
Active Recovery	< 55%	<60%	Very Light	Infinity

SPECIFICATIONS

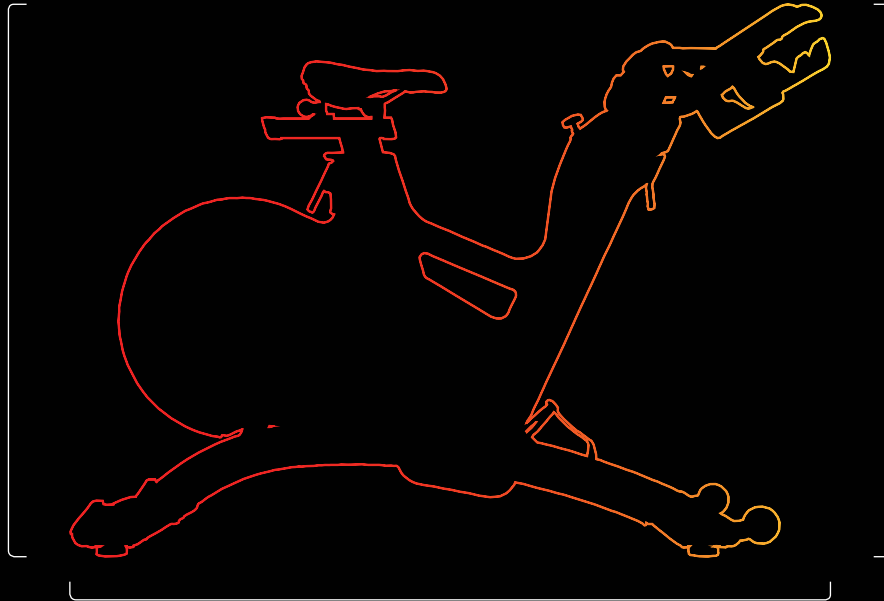

52" / 132 cm

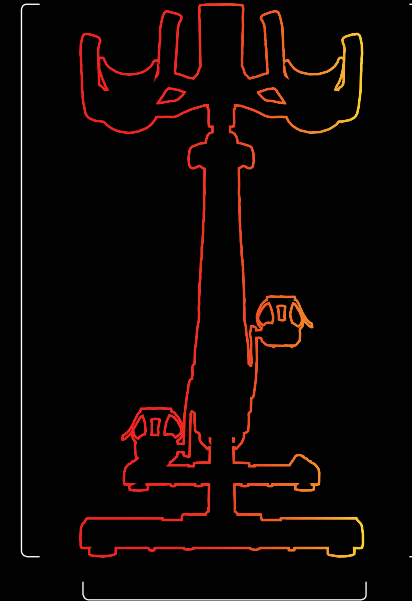

40.2"
102.0 cm

20.5" / 52 cm

WATTRATE® DIRECT POWER METER	Yes, +/-1% tolerance, direct at spindle
COMPUTER	WattRate® TFT Computer 2.0
POWER SUPPLY	Self-powered generator
RESISTANCE SYSTEM	Magnetic
EMERGENCY STOP	Push
FLYWHEEL	Rear, aluminum, evenly-weighted
DRIVETRAIN	2-Stage hybrid Poly-V & tooth belt
DRIVETRAIN GEAR RATIO	1:11
FRAME COLOR	Matte slate
FRAME MATERIAL	Steel
SHROUDS & GUARDS	Full frame
FRAME DESIGN	Off-set
ADJUSTMENT TYPE	Over-cam low pressure flip levers
POSTS & SLIDERS	Aluminum, stepless, user assist' adjustment
Q-FACTOR	6.1" / 155mm

CRANK TYPE	CrMo 6.79" / 172,5mm
PEDAL TYPE	Dual-sided SPD & toe cage
HANDLEBAR	Superior ergo - formed, multi-position, soft PVC
HANDLEBAR ADJUSTMENTS	Vertical & horizontal
SADDLE	Unisex ultra padded sport saddle
SADDLE ADJUSTMENTS	Vertical & horizontal
WATER BOTTLE HOLDER	Dual, integrated on handlebar
FRAME STABILIZER BARS	Oversized, hidden bolts & fixings
PROTECTION AND STRETCH PLATES	Molded form-fit with stretch plate
MAX USER WEIGHT	330 lbs / 150 kg
ASSEMBLED WEIGHT	119 lbs / 54 kg
ASSEMBLED DIMENSIONS	52" x 20.5" x 40.2" / 132 x 52 x 102 cm
LEVELING FEET	4
TRANSPORT WHEELS	2
WARRANTY (PARTS)	3 years



LifeFitness

INDOOR  CYCLING
GROUP

©2019 Life Fitness, LLC. All Rights Reserved. Life Fitness, Hammer Strength, Cybex, ICG and SCIFIT are registered trademarks of Life Fitness, LLC and its affiliated companies and subsidiaries. Brunswick and related trademarks used under license from Brunswick Corporation. Bluetooth is a registered trademark of Bluetooth SIG.